

PART# 76-4065B



TOOLS NEEDED

3/4" SOCKET
3/4" WRENCH
RATCHET
6" EXTENSION
TORQUE WRENCH

QTY	DESCRIPTION
2	STEP BARS (1 DRIVER SIDE ; 1 PASSENGER SIDE)
1	FRONT BRACKET (PASSENGER SIDE)
1	FRONT BRACKET (DRIVER SIDE)
1	REAR BRACKET (PASSENGER SIDE)
1	REAR BRACKET (DRIVER SIDE)
2	FRONT SUPPORT BRACES
6	1/2"-13 x 2" L HEX HEAD BOLTS
2	1/2" LARGE FLAT WASHERS
8	1/2" FLAT WASHERS
8	1/2" LOCK WASHERS
4	1/2"-13 HEX NUTS

STEPS	INSTALLATION
1	CHECK CONTENTS OF BOX FOR DAMAGE OR MISSING ITEMS
2	INSERT FRONT SUPPORT BRACE INTO FRAME HOLE. ATTACH FRONT BRACKET WITH 1/2" FLAT WASHER, 1/2" LOCK WASHER, AND 1/2"-13 HEX NUT. HAND TIGHTEN AND REPEAT ON THE OTHER SIDE.
3	ATTACH REAR BRACKETS WITH 1/2"-13*2" HEX HEAD BOLT, 1/2" LARGE FLAT WASHER 1/2" FLAT WASHER, 1/2" LOCK WASHER AND 1/2"-13 HEX NUT. HAND TIGHTEN AND REPEAT ON OTHER SIDE.
4	ATTACH STEP BARS TO BRACKETS WITH 1/2"-13*2" HEX HEAD BOLTS, 1/2" FLAT WASHERS, 1/2" LOCK WASHERS.
5	MAKE SURE STAINLESS STEP BAR IS ALIGNED WITH TRUCK. TIGHTEN ALL MOUNTING BRACKET BOLTS TO 65 FT. LBS.

PART# 76-4065B

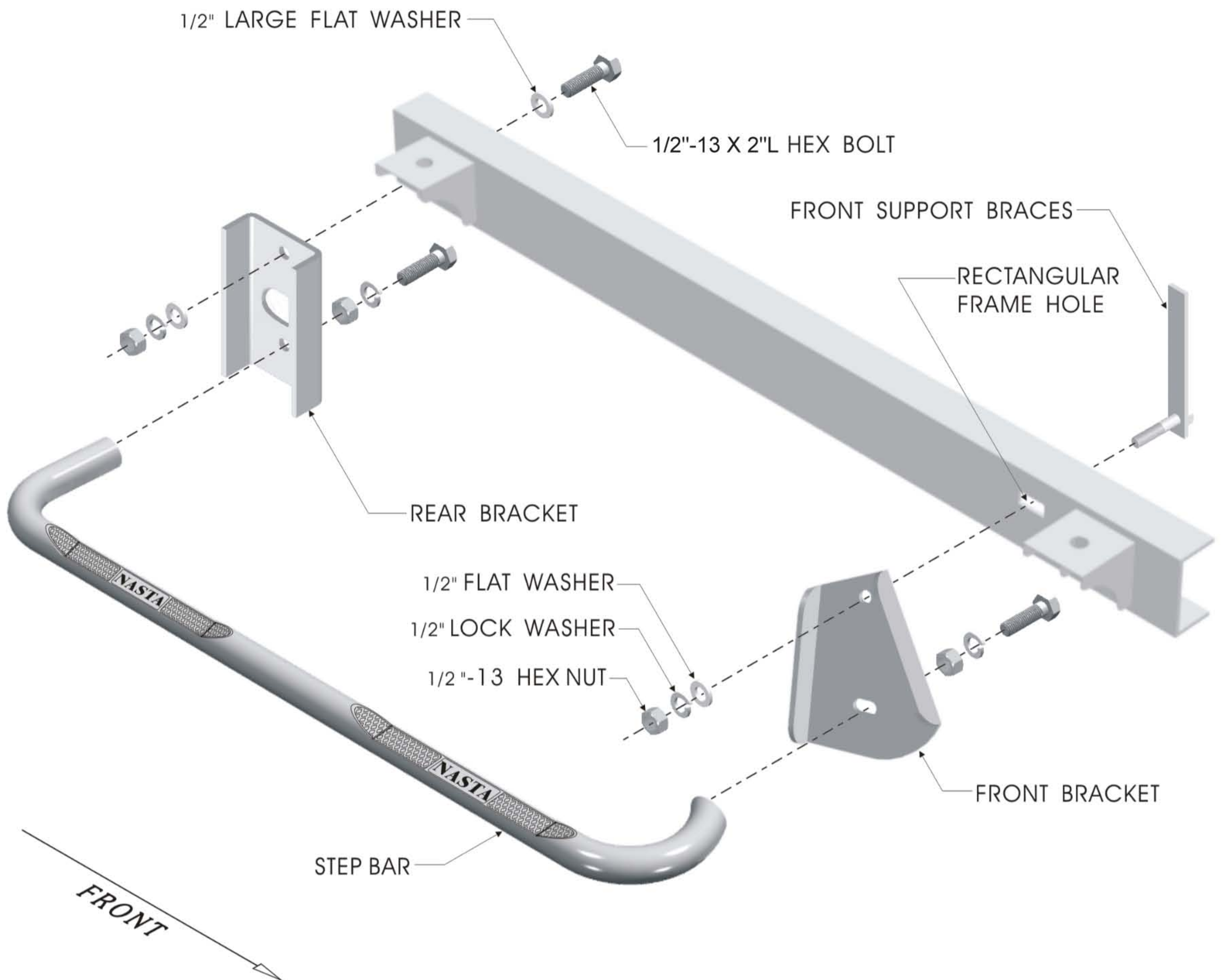

PASSENGER SIDE INSTALLATION SHOWN - DRIVER SIDE OPPOSITE

NASTA[®]

NASTA INTERNATIONAL, INC.
Div. of **TA CHEN** INT'L CORP.
5 Boswell Bristol, TN 37620 U.S.A
TEL:(423)764-0700.FAX(423)764-7849.Toll Free(877)891-0816
www.nastainternational.com